

XC15 SERIES UNITS

The XC15 is a high efficiency residential split-system condensing unit, which features a scroll compressor and R-410A refrigerant. Units are available in 2, 2-1/2, 3, 3-1/2, 4 and 5 ton sizes. The series is designed for use with an expansion valve only (approved for use with R-410A) in the indoor unit. This manual is divided into sections which discuss the major components, refrigerant system, charging procedure, maintenance and operation sequence. Information contained in this manual is intended for use by qualified service technicians only. All specifications are subject to change.

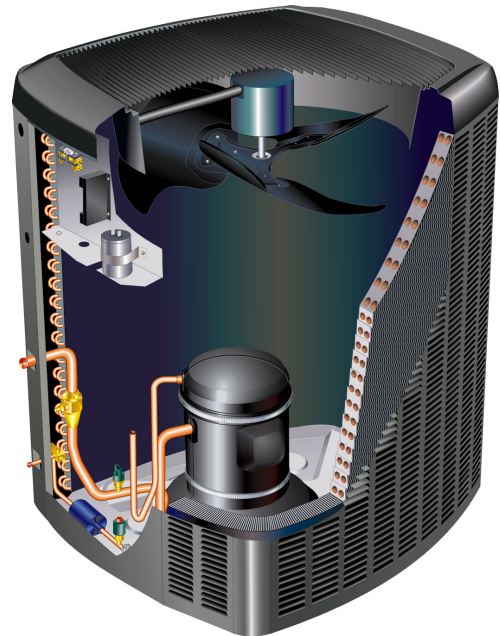

⚠ CAUTION
Physical contact with metal edges and corners while applying excessive force or rapid motion can result in personal injury. Be aware of, and use caution when working nearby these areas during installation or while servicing this equipment.

⚠ IMPORTANT
Operating pressures of this R-410A unit are higher than pressures in R-22 units. Always use service equipment rated for R-410A.

⚠ WARNING
Improper installation, adjustment, alteration, service or maintenance can cause property damage, personal injury or loss of life. Installation and service must be performed by a qualified installer or service agency.

⚠ WARNING
 Electric shock hazard. Can cause injury or death. Before attempting to perform any service or maintenance, turn the electrical power to unit OFF at disconnect switch(es). Unit may have multiple power supplies.

⚠ CAUTION
To prevent personal injury, or damage to panels, unit or structure, be sure to observe the following:
While installing or servicing this unit, carefully stow all removed panels out of the way, so that the panels will not cause injury to personnel, nor cause damage to objects or structures nearby, nor will the panels be subjected to damage (e.g., being bent or scratched).
While handling or stowing the panels, consider any weather conditions, especially windy conditions, that may cause panels to be blown around and battered.

TABLE OF CONTENTS

General	1
Specifications / Electrical Data	2
I Application	3
II Unit Components	3
III Refrigerant System	13
IV Charging	14
V Service and Recovery	19
VI Maintenance	19
VII Diagrams and Sequence of Operation	20

SPECIFICATIONS								
General Data	Model No.	XC15-024	XC15-030	XC15-036	XC15-042	XC15-048	XC15-060	
	Nominal Tonnage	2	2.5	3	3.5	4	5	
Connections (sweat)	Liquid line (o.d.) - in.	3/8	3/8	3/8	3/8	3/8	3/8	
	Suction line (o.d.) - in.	3/4	3/4	3/4	7/8	7/8	1-1/8	
Refrigerant	¹ R-410A charge furnished	8 lbs. 10 oz.	8 lbs. 10 oz.	9 lbs. 2 oz.	9 lbs. 13 oz.	12 lbs. 2 oz.	13 lbs. 0 oz.	
Outdoor Coil	Net face area - sq. ft.	Outer coil	20.73	20.73	20.73	20.73	27.21	27.21
		Inner coil	20.08	20.08	20.08	20.08	26.36	26.36
	Tube diameter - in.	5/16	5/16	5/16	5/16	5/16	5/16	
	No. of rows	2	2	2	2	2	2	
	Fins per inch	22	22	22	22	22	22	
Outdoor Fan	Diameter - in.	26	26	26	26	26	26	
	No. of blades	3	3	3	3	3	3	
	Motor hp	1/15	1/15	1/12	1/12	1/5	1/5	
	Cfm	2100	2100	2300	2300	3910	3910	
	Rpm	825	825	825	825	825	825	
	Watts	100	100	112	112	212	212	
Shipping Data - lbs. 1 pkg.		273	274	276	299	346	351	
ELECTRICAL DATA								
Line voltage data - 60hz		208/230V-1ph						
² Maximum overcurrent protection (amps)		30	30	35	40	50	60	
	³ Minimum circuit ampacity	17.4	18.1	21.5	23.1	28.4	34.1	
Compressor	Rated load amps	13.5	14.1	16.7	17.9	21.8	26.4	
	Locked rotor amps	58.3	73.0	79.0	112.0	117.0	134.0	
	Power factor	0.97	0.97	0.98	0.93	0.96	0.98	
Outdoor Fan Motor	Full load amps	0.5	0.5	0.65	0.65	1.1	1.1	
	Locked rotor amps	0.8	0.8	1.1	1.1	2.1	2.1	
OPTIONAL ACCESSORIES - must be ordered extra								
Compressor Hard Start Kit	88M91	•	•	•	•	•	•	
Compressor Low Ambient Cut-Off	45F08	•	•	•	•	•	•	
Compressor Time-Off Control	47J27	•	•	•	•	•	•	
Freezestat	3/8 in. tubing	93G35	•	•	•	•	•	
	1/2 in. tubing	39H29	•	•	•	•	•	
	5/8 in. tubing	50A93	•	•	•	•	•	
Indoor Blower Relay	40K58	•	•	•	•	•	•	
Low Ambient Kit	34M72	•	•	•	•	•	•	
SignatureStat™ Home Comfort Control	81M27	•	•	•	•	•	•	
Refrigerant Line Sets	L15-41-20	L15-41-40	•	•	•			
	L15-41-30	L15-41-50						
	L15-65-30	L15-65-40				•	•	
		L15-65-50						
	Field Fabricate						•	
Time Delay Relay	58M81	•	•	•	•	•	•	

NOTE - Extremes of operating range are plus 10% and minus 5% of line voltage.

¹ Refrigerant charge sufficient for 15 ft. (4.6 m) length of refrigerant lines.

² HACR type breaker or fuse.

³ Refer to National or Canadian Electrical Code manual to determine wire, fuse and disconnect size requirements.

I-APPLICATION

All major components (indoor blower and coil) must be matched according to Lennox recommendations for the compressor to be covered under warranty. Refer to the Engineering Handbook for approved system matchups. A misapplied system will cause erratic operation and can result in early compressor failure.

⚠ CAUTION

In order to avoid injury, take precaution when lifting heavy objects.

II-Unit Components

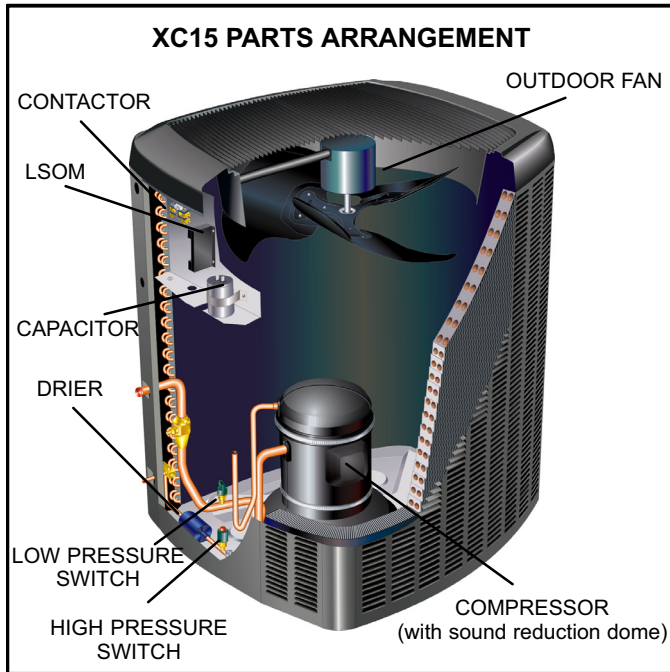

FIGURE 1

Removing/Reinstalling Panels

Open the *access panels* as described in figure 2.

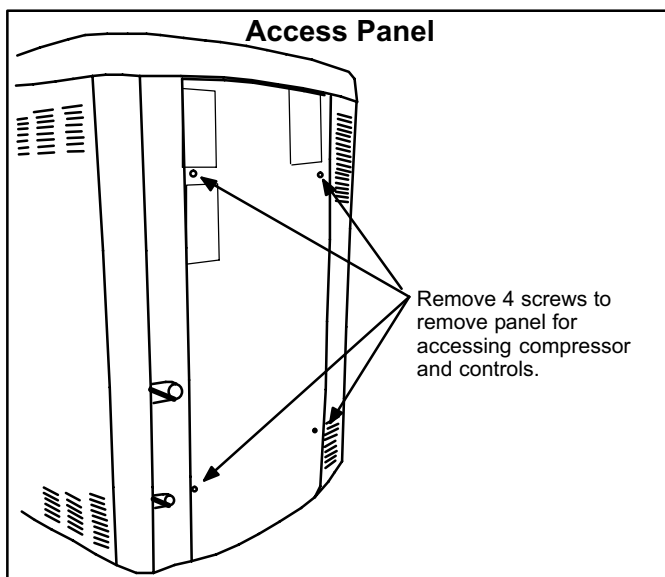

FIGURE 2

Remove the louvered panels as follows:

1. Remove 2 screws, allowing the panel to swing open slightly.
2. **Hold the panel firmly throughout this procedure.** Rotate bottom corner of panel away from hinge corner post until lower 3 tabs clear the slots (see figure 3, Detail B).
3. Move panel down until lip of upper tab clears the top slot in corner post (see figure 3, Detail A).

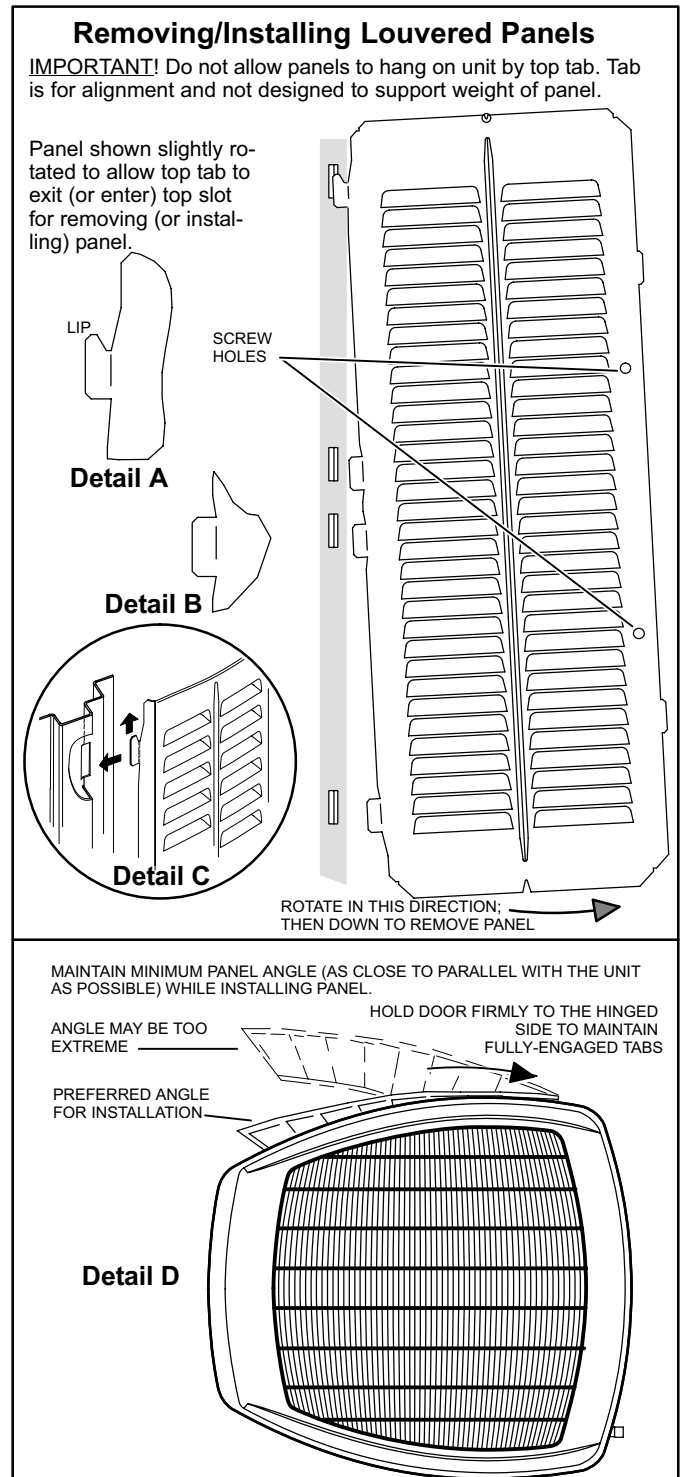

FIGURE 3

**ELECTROSTATIC DISCHARGE (ESD)
Precautions and Procedures**

⚠ CAUTION

Electrostatic discharge can affect electronic components. Take precautions during unit installation and service to protect the unit's electronic controls. Precautions will help to avoid control exposure to electrostatic discharge by putting the unit, the control and the technician at the same electrostatic potential. Neutralize electrostatic charge by touching hand and all tools on an unpainted unit surface before performing any service procedure.

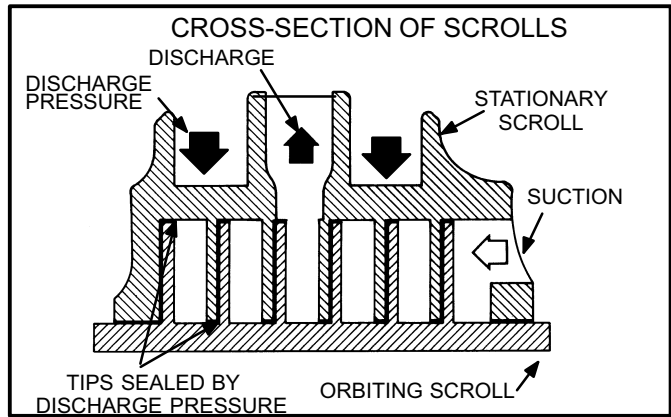

FIGURE 6

The counterclockwise orbiting scroll draws gas into the outer crescent shaped gas pocket created by the two scrolls (figure 7- 1). The centrifugal action of the orbiting scroll seals off the flanks of the scrolls (figure 7- 2). As the orbiting motion continues, the gas is forced toward the center of the scroll and the gas pocket becomes compressed (figure 7-3). When the compressed gas reaches the center, it is discharged vertically into a chamber and discharge port in the top of the compressor. The discharge pressure forcing down on the top scroll helps seal off the upper and lower edges (tips) of the scrolls (figure 6). During a single orbit, several pockets of gas are compressed simultaneously providing smooth continuous compression.

The scroll compressor is tolerant to the effects of liquid return. If liquid enters the scrolls, the orbiting scroll is allowed to separate from the stationary scroll. The liquid is worked toward the center of the scroll and is discharged. If the compressor is replaced, conventional Lennox cleanup practices must be used.

Due to its efficiency, the scroll compressor is capable of drawing a much deeper vacuum than reciprocating compressors. Deep vacuum operation can cause internal fusite arcing resulting in damaged internal parts and will result in compressor failure. This type of damage can be detected and will result in denial of warranty claims. The scroll compressor can be used to pump down refrigerant as long as the pressure is not reduced below 7 psig.

NOTE - During operation, the head of a scroll compressor may be hot since it is in constant contact with discharge gas.

The scroll compressors in all XC15 model units are designed for use with R-410A refrigerant and operation at high pressures. Compressors are shipped from the factory with 3MA (32MMA) P.O.E. oil. See electrical section in this manual for compressor specifications.

A-Scroll Compressor (B1)

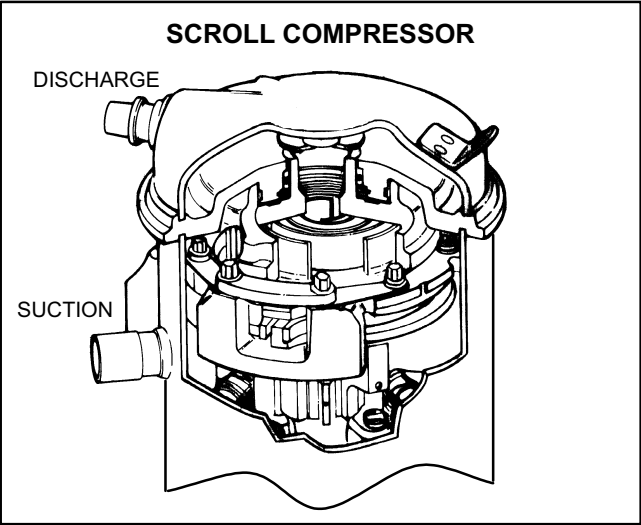

FIGURE 4

The scroll compressor design is simple, efficient and requires few moving parts. A cutaway diagram of the scroll compressor is shown in figure 4. The scrolls are located in the top of the compressor can and the motor is located just below. The oil level is immediately below the motor.

The scroll is a simple compression concept centered around the unique spiral shape of the scroll and its inherent properties. Figure 5 shows the basic scroll form. Two identical scrolls are mated together forming concentric spiral shapes (figure 6). One scroll remains stationary, while the other is allowed to "orbit" (figure 7). Note that the orbiting scroll does not rotate or turn but merely "orbits" the stationary scroll.

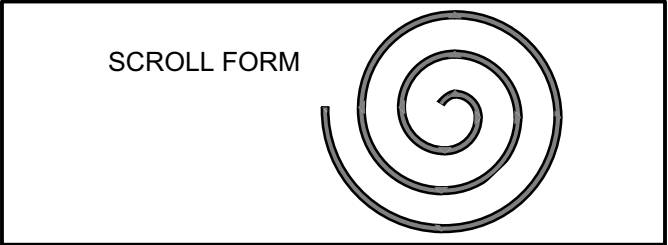

FIGURE 5

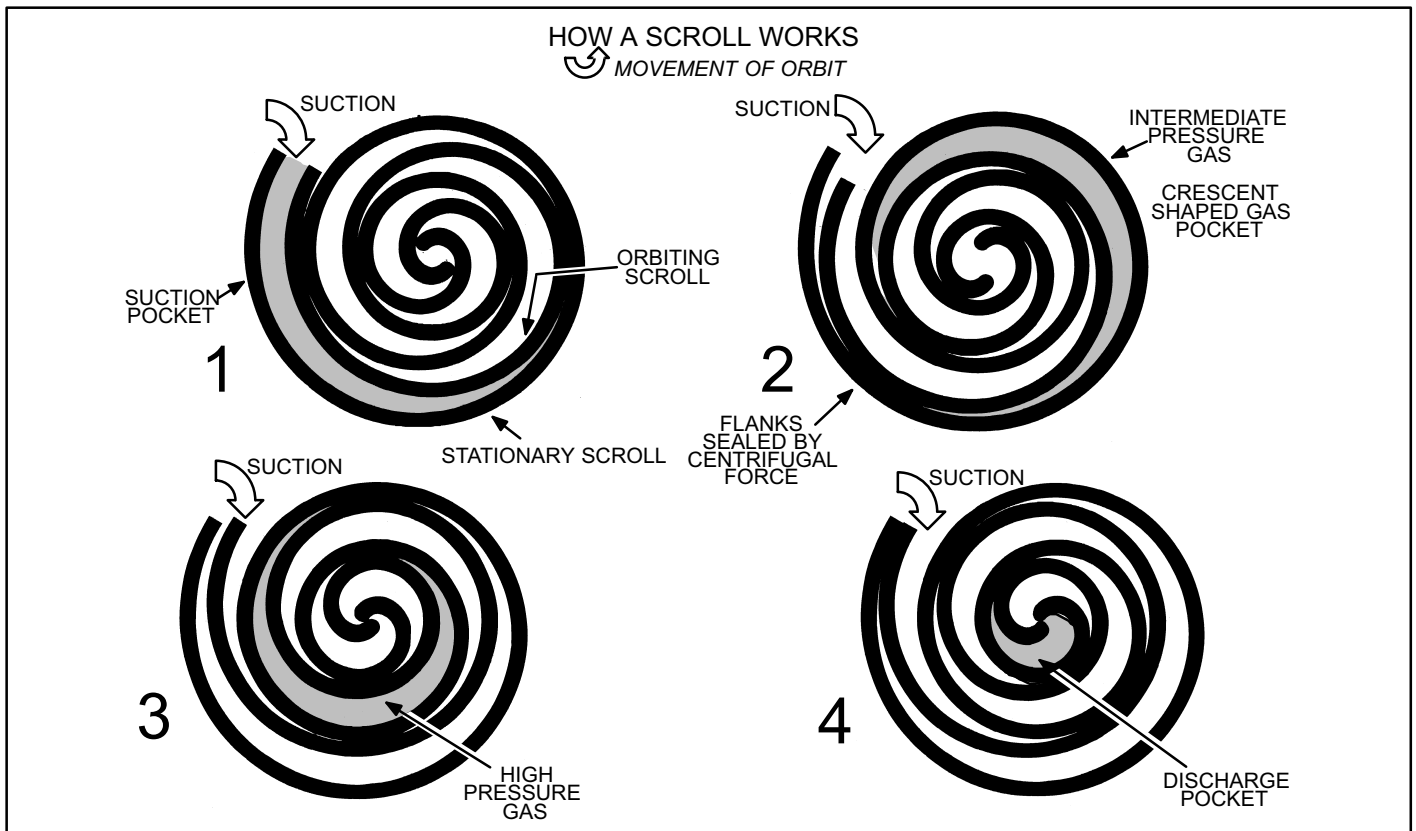

FIGURE 7

B-Capacitor (C12)

The compressor and fan use a split capacitor. A single dual capacitor is used for both the fan motor and compressor motor. The two sides (fan and compressor) of the capacitor have different mfd ratings and may change with each compressor. The capacitor is located in the unit control box.

C-Condenser Fan Motor (B4)

XP15 units use a single-phase PSC fan motor which requires a

D-High Pressure Switch (S4)

⚠ IMPORTANT

Pressure switch settings for R-410A refrigerant will be significantly higher than units with R-22.

A manual-reset, single-pole/single-throw high pressure switch is located in the liquid line. The switch shuts off the compressor by de-energizing K1 when liquid line pressure rises above the factory setting. The switch is normally closed and is permanently adjusted to trip (open) at 590 ± 10 psi. See figure 1 for switch location.

E-Low Pressure Switch (S87)

All XC15 units are equipped with an auto-reset, single-pole/single-throw low pressure switch is located in the vapor line. This switch shuts off the compressor by de-energizing K1 when vapor line pressure drops below the factory setting. The switch is closed during normal operating pres-

sure conditions and is permanently adjusted to trip (open) at 40 ± 5 psi. The switch automatically resets when vapor line pressure rises above 90 ± 5 psi. See figure 1 for switch location.

F-Contactor (K1)

The compressor is energized by a contactor located in the control box. XC15 units are single-phase with single-pole contactors. See figure 1 for location.

⚠ DANGER

Shock Hazard
Remove all power at disconnect before removing access panel. XC15 units use single-pole contactors. Potential exists for electrical shock resulting in injury or death. Line voltage exists at all components (even when unit is not in operation).

G-Crankcase Heater (HR1) & Thermostat (S40)

The compressor in the unit is equipped with a 40 watt, belly band type crankcase heater. HR1 prevents liquid from accumulating in the compressor. HR1 is controlled by a thermostat located on the liquid line. When liquid line temperature drops below 50° F the thermostat closes energizing HR1. The thermostat will open, de-energizing HR1 once liquid line temperature reaches 70° F .

H-Drier

A filter drier designed for all XC15 model units is factory installed in the liquid line. The filter drier is designed to remove moisture and foreign matter, which can lead to compressor failure.

Moisture and / or Acid Check

Because POE oils absorb moisture, the dryness of the system must be verified any time the refrigerant system is exposed to open air. A compressor oil sample must be taken to determine if excessive moisture has been introduced to the oil. Table 1 lists kits available from Lennox to check POE oils.

If oil sample taken from a system that has been exposed to open air does not test in the dry color range, the filter drier **MUST** be replaced.

⚠ IMPORTANT

Replacement filter drier MUST be approved for R-410A refrigerant and POE application.

Foreign Matter Check

It is recommended that a liquid line filter drier be replaced when the pressure drop across the filter drier is greater than 4 psig.

TABLE 1

KIT	CONTENTS	TUBE SHELF LIFE
10N46 - Refrigerant Analysis	Checkmate-RT700	
10N45 - Acid Test Tubes	Checkmate-RT750A (three pack)	2 - 3 years @ room temperature. 3+ years refrigerated
10N44 - Moisture Test Tubes	Checkmate - RT751 Tubes (three pack)	6 - 12 months @ room temperature. 2 years refrigerated
74N40 - Easy Oil Test Tubes	Checkmate - RT752C Tubes (three pack)	2 - 3 years @ room temperature. 3+ years refrigerated
74N39 - Acid Test Kit	Sporlan One Shot - TA-1	

MEASURING FILTER DRIER PRESSURE DROP

- 1- Shut off power to unit. Remove access and service panel.
- 2- Remove high pressure switch from fitting next to filter drier. (A schrader core is located under the high pressure switch).
- 3- Install high pressure gauge hose onto high pressure switch fitting. Secure **service** panel back in place
- 4- Turn power on to unit and turn room thermostat to call for cooling.
- 5- Record pressure reading on gauge.
- 6- Remove hose from high pressure fitting and install on liquid line valve.
- 7- Read liquid line valve pressure.
- 8- High pressure fitting pressure - liquid line valve pressure = filter drier pressure drop.
- 9- If pressure drop is greater than 4 psig replace filter drier. See figure 9.
- 10- Re-install high pressure switch.

Note - Service panel must be in place while unit is operational for an accurate pressure drop reading.

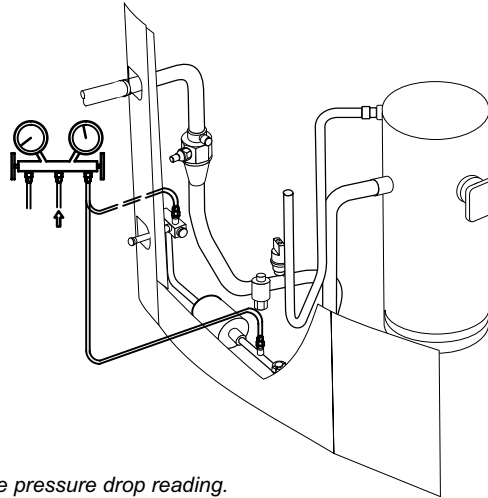

FIGURE 8

REPLACING FILTER DRIER

- 1- Recover all refrigerant from unit.
- 2- Remove original filter drier.
- 3- Install new filter drier in existing location or alternate location as shown. *Proper brazing procedures should be followed.*
- 4- Evacuate system. See section IV- part B-.
- 5- Recharge system. See section IV- part C-.

alternate location

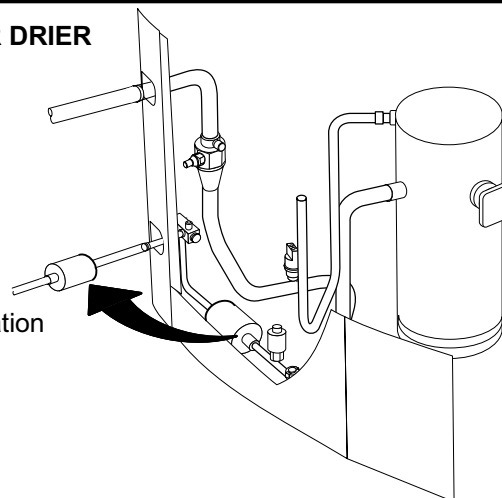

FIGURE 9

TABLE 2

Lennox System Operation Monitor LED Troubleshooting Codes		
Status LED Condition	Status LED Description	Status LED Troubleshooting Information
Green "Power" LED ON	Module has power	24VAC control power is present at the module terminal.
Green "Power" LED OFF	Module not powering up	Determine/verify that both R and C module terminals are connected and voltage is present between both terminals.
Red "Trip" LED ON	System and compressor check out OK Thermostat demand signal Y1 is present, but compressor not running	<ol style="list-style-type: none"> 1 Verify Y terminal is connected to 24VAC at contactor coil. 2 Verify voltage at contactor coil falls below 0.5VAC when off. 3 Verify 24VAC is present across Y and C when thermostat demand signal is present; if not present, R and C wires are reversed. 1 Compressor protector is open. 2 Outdoor unit power disconnect is open. 3 Compressor circuit breaker or fuse(s) is open. 4 Broken wire or connector is not making contact. 5 Low pressure switch open if present in the system. 6 Compressor contactor has failed to close.
Red "Trip" & Yellow "Alert" LEDs Flashing	Simultaneous flashing.	Indicates that the control circuit voltage is too low for operation.
Yellow "Alert" Flash Code 1*	Long Run Time - Compressor is running extremely long run cycles	<ol style="list-style-type: none"> 1 Low refrigerant charge. 2 Evaporator blower is not running. 3 Evaporator coil is frozen. 4 Faulty metering device. 5 Condenser coil is dirty. 6 Liquid line restriction (filter drier blocked if present). 7 Thermostat is malfunctioning.
Yellow "Alert" Flash Code 2*	System Pressure Trip - Discharge or suction pressure out of limits or compressor overloaded	<ol style="list-style-type: none"> 1 High head pressure. 2 Condenser coil poor air circulation (dirty, blocked, damaged). 3 Condenser fan is not running. 4 Return air duct has substantial leakage. 5 If low pressure switch is present, see Flash Code 1 information.
Yellow "Alert" Flash Code 3*	Short Cycling - Compressor is running only briefly	<ol style="list-style-type: none"> 1 Thermostat demand signal is intermittent. 2 Time delay relay or control board is defective. 3 If high pressure switch is present, see Flash Code 2 information. 4 If low pressure switch is present, see Flash Code 1 information.
Yellow "Alert" Flash Code 4*	Locked Rotor	<ol style="list-style-type: none"> 1 Run capacitor has failed. 2 Low line voltage (contact utility if voltage at disconnect is low). 3 Excessive liquid refrigerant in the compressor. 4 Compressor bearings are seized.
Yellow "Alert" Flash Code 5*	Open Circuit	<ol style="list-style-type: none"> 1 Outdoor unit power disconnect is open. 2 Unit circuit breaker or fuse(s) is open. 3 Unit contactor has failed to close. 4 High pressure switch is open and requires manual reset. 5 Open circuit in compressor supply wiring or connections. 6 Unusually long compressor protector reset time due to extreme ambient temperature. 7 Compressor windings are damaged.
Yellow "Alert" Flash Code 6*	Open Start Circuit - Current only in run circuit	<ol style="list-style-type: none"> 1 Run capacitor has failed. 2 Open circuit in compressor start wiring or connections. 3 Compressor start winding is damaged.
Yellow "Alert" Flash Code 7*	Open Run Circuit - Current only in start circuit	<ol style="list-style-type: none"> 1 Open circuit in compressor start wiring or connections. 2 Compressor start winding is damaged.
Yellow "Alert" Flash Code 8*	Welded Contactor - Compressor always runs	<ol style="list-style-type: none"> 1 Compressor contactor failed to open. 2 Thermostat demand signal not connected to module.
Yellow "Alert" Flash Code 9*	Low Voltage - Control circuit <17VAC	<ol style="list-style-type: none"> 1 Control circuit transformer is overloaded. 2 Low line voltage (contact utility if voltage at disconnect is low).

*Flash code number corresponds to a number of LED flashes, followed by a pause, and then repeated. Reset ALERT flash code by removing 24VAC power from monitor; last code will display for 1 minute after monitor is powered on.

I-Lennox System Operation Monitor (A132)

The Lennox system operation monitor (LSOM) is a 24 volt powered module, (see diagnostic module A132 on wiring diagram and figure 10) wired directly to the indoor unit. The LSOM is located in the control box and is used to troubleshoot problems in the system. The module has three LED's for troubleshooting: GREEN indicates power status, YELLOW indicates an abnormal condition and RED indicates thermostat demand, but compressor not operating. See table 2 for troubleshooting codes.

The diagnostic indicator detects the most common fault conditions in the air conditioning system. When an abnormal condition is detected, the module communicates the specific condition through its ALERT and TRIP lights. The module is capable of detecting both mechanical and electrical system problems. See figure 10 for the system operation monitor.

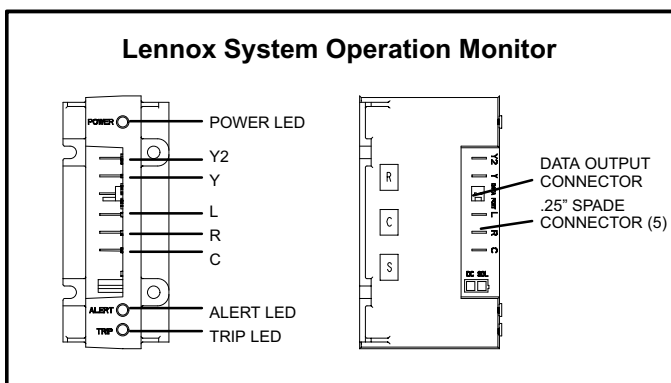

FIGURE 10

⚠ IMPORTANT

This monitor does not provide safety protection. The monitor is a monitoring device only and cannot control or shut down other devices.

LED Functions

Alert LED (green) - Indicates voltage within the range of 19-28VAC is present at the system monitor connections.

Alert LED (yellow) - communicates an abnormal system condition through a unique Flash Code—the alert LED flashes a number of times consecutively; then pauses; then repeats the process. This consecutive flashing correlates to a particular abnormal condition.

Trip LED (red) - indicates there is a demand signal from the thermostat but no current to the compressor is detected by the module.

Flash code number - corresponds to a number of LED flashes, followed by a pause, and then repeated.

Trip & Alert LEDs flashing simultaneously - indicates that the control circuit voltage is too low for operation.

Reset ALERT flash code by removing 24VAC power from monitor. Last ALERT flash code will display for 1 minute after monitor is powered on.

Thermostat

The Lennox system operation monitor (LSOM) requires a two-stage room thermostat to operate properly.

L terminal connection—The L connection is used to communicate alert codes to the room thermostat. On selected Lennox SignatureStat™ thermostats, a blinking "check" LED will display on the room thermostat and on select White-Rodgers room thermostats, an icon on the display will flash. Either will flash at the same rate as the LSOM yellow alert LED.

NOTE - ROOM THERMOSTAT WITH SERVICE OR CHECK LIGHT FEATURE - The room thermostat may blink the "Check" or "Service" LED or it may come on solid. Confirm fault by observing and interpreting the code from the LSOM yellow alert LED at the unit.

Installation verification-LSOM—To verify correct LSOM installation, two functional tests can be performed. Disconnect power from the compressor and force a thermostat call for cooling. The red trip LED should turn on indicating a compressor trip as long as 24VAC is measured at the Y terminal. If the red LED does not function as described, refer to table 2 to verify the wiring. Disconnect power from the compressor and 24VAC power from LSOM. Remove the wire from the Y terminal of LSOM and reapply power to the compressor, allowing the compressor to run. The yellow alert LED will begin flashing a code 8 indicating a welded contactor. Disconnect power from the compressor and 24VAC power from the LSOM. While the LSOM is off, reattach the wire to the Y terminal. Reapply power to the compressor and 24VAC power to the LSOM; the yellow alert LED will flash the previous code 8 for one minute and then turn off. If the yellow LED does not function as described, refer to table 2 to verify the wiring.

Resetting alert codes—Alert codes can be reset manually or automatically:

Manual reset: Cycle the 24VAC power to LSOM off and on.

Automatic reset: After an alert is detected, the LSOM continues to monitor the compressor and system. When/if conditions return to normal, the alert code is turned off automatically.

III-REFRIGERANT SYSTEM

⚠ WARNING

R-410A refrigerant can be harmful if it is inhaled. R-410A refrigerant must be used and recovered responsibly.

Failure to follow this warning may result in personal injury or death.

A-Plumbing

Field refrigerant piping consists of liquid and vapor lines from the outdoor unit (sweat connections) to the indoor coil (flare or sweat connections). Use Lennox L15 (sweat, non-flare) series line sets as shown in table 3 or use field-fabricated refrigerant lines. Valve sizes are also listed in table 3.

TABLE 3

XC15	Valve Size Connections		Recommended Line Set		
	Liquid Line	Vapor Line	Liquid Line	Vapor Line	L15 Line Sets
-024 -030 -036	3/8 in. (10 mm)	7/8 in. (22 mm)	3/8 in. (10 mm)	7/8 in. (22 mm)	L15-65 15 ft. - 50 ft. (4.6 m - 15 m)
-042 -048	3/8 in. (10 mm)	7/8 in. (22 mm)	3/8 in. (10 mm)	7/8 in. (22 mm)	L15-65 15 ft. - 50 ft. (4.6 m - 15 m)
-060	3/8 in. (10 mm)	1-1/8 in. (29 mm)	3/8 in. (10 mm)	1-1/8 in. (29 mm)	Field Fabricated

NOTE - When installing refrigerant lines, refer to Lennox Technical Support Product Applications for assistance. In addition, be sure to consider the following points:

Select line set diameters from table 3 to ensure that oil returns to the compressor.

Units are designed for line sets of up to fifty feet (15 m); for longer line sets, consult piping guidelines.

Size vertical vapor riser to maintain minimum velocity at minimum capacity.

B-Service Valves

The liquid line and vapor line service valves (figures 11 and 12) and gauge ports are used for leak testing, evacuating, charging and checking charge. See table 4 for torque requirements.

Each valve is equipped with a service port which has a factory-installed Schrader valve. A service port cap protects the Schrader valve from contamination and serves as the primary leak seal.

TABLE 4

Part	Recommended Torque	
Service valve cap	8 ft.- lb.	11 NM
Sheet metal screws	16 in.- lb.	2 NM
Machine screws #10	28 in.- lb.	3 NM
Compressor bolts	90 in.- lb.	10 NM
Gauge port seal cap	8 ft.- lb.	11 NM

To Access Schrader Port:

- 1 - Remove service port cap with an adjustable wrench.
- 2 - Connect gauge to the service port.
- 3 - When testing is complete, replace service port cap. Tighten finger tight, then an additional 1/6 turn.

To Open Service Valve:

- 1 - Remove the stem cap with an adjustable wrench.
- 2 - Use a service wrench with a hex-head extension to back the stem out counterclockwise as far as it will go.
NOTE - Use a 3/16" hex head extension for 3/8" line sizes.
- 3 - Replace the stem cap. Tighten finger tight, then tighten an additional 1/6 turn.

To Close Service Valve:

- 1 - Remove the stem cap with an adjustable wrench.
- 2 - Use a service wrench with a hex-head extension to turn the stem clockwise to seat the valve. Tighten the stem firmly.
NOTE - Use a 3/16" hex head extension for 3/8" line sizes.
- 3 - Replace the stem cap. Tighten finger tight, then tighten an additional 1/6 turn.

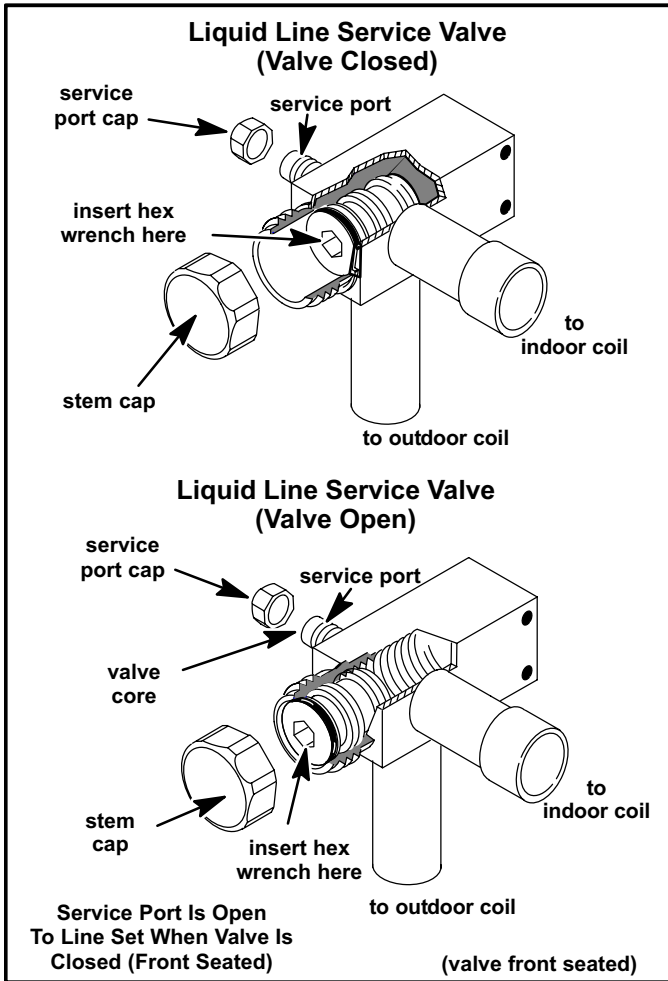

FIGURE 11

Vapor Line Ball Valve – All Units

Vapor line service valves function the same way as the other valves, the difference is in the construction. These valves are not rebuildable. If a valve has failed, you must replace it. A ball valve is illustrated in figure 12.

The ball valve is equipped with a service port with a factory-installed Schrader valve. A service port cap protects the Schrader valve from contamination and assures a leak-free seal.

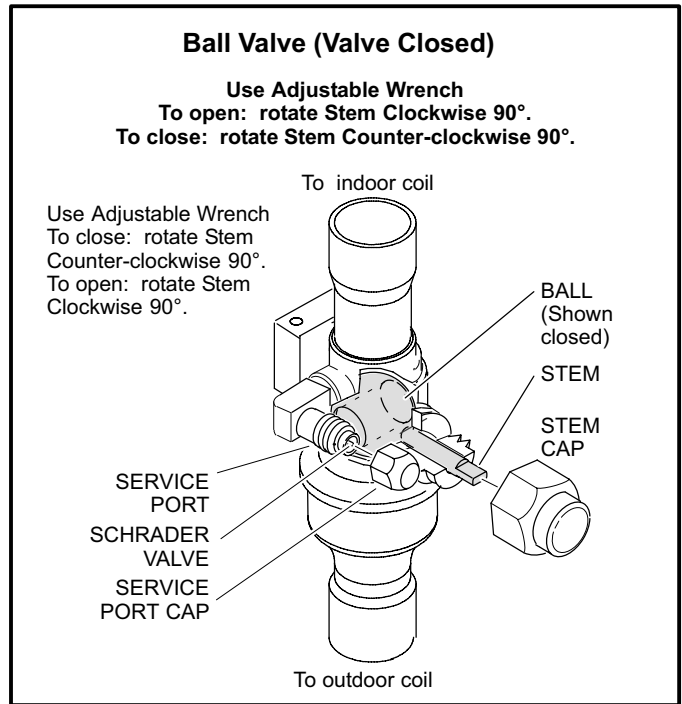

FIGURE 12

IV-CHARGING

⚠ IMPORTANT

The Clean Air Act of 1990 bans the intentional venting of (CFC's and HFC's) as of July 1, 1992. Approved methods of recovery, recycling or reclaiming must be followed. Fines and/or incarceration may be levied for noncompliance.

Units are factory charged with the amount of R-410A refrigerant indicated on the unit rating plate. This charge is based on a matching indoor coil and outdoor coil with 15 ft. (4.6m) line set. For varying lengths of line set, refer to table 5 for refrigerant charge adjustment.

TABLE 5

Liquid Line Set Diameter	Oz. per 5 ft. (grams per 1.5m) adjust from 15 ft. (4.6 m) line set*
3/8 in. (9.5 mm)	3 ounces per 5 feet (85 g per 1.5 m)

**If line length is greater than 15 ft. (4.6 m), add this amount. If line length is less than 15 ft. (4.6 m), subtract this amount.*

A-Leak Testing

After the line set has been connected to the indoor and outdoor units, check the line set connections and indoor unit for leaks.

WARNING

Refrigerant can be harmful if it is inhaled. Refrigerant must be used and recovered responsibly.

Failure to follow this warning may result in personal injury or death.

WARNING

Fire, Explosion and Personal Safety Hazard. Failure to follow this warning could result in damage, personal injury or death.

Never use oxygen to pressurize or purge refrigeration lines. Oxygen when exposed to a spark or open flame can cause damage by fire and or an explosion, that could result in personal injury or death.

WARNING

Danger of explosion. Can cause equipment damage, injury or death. When using a high pressure gas such as dry nitrogen to pressurize a refrigeration or air conditioning system, use a regulator that can control the pressure down to 1 or 2 psig (6.9 to 13.8 kPa).

Using an Electronic Leak Detector

- 1 - Connect the high pressure hose of the manifold gauge set to the vapor valve service port. (Normally, the high pressure hose is connected to the liquid line port, however, connecting it to the vapor port helps to protect the manifold gauge set from damage caused by high pressure.)
- 2 - With both manifold valves closed, connect the cylinder of R-410A refrigerant. Open the valve on the R-410A cylinder (vapor only).
- 3 - Open the high pressure side of the manifold to allow R-410A into the line set and indoor unit. Weigh in a trace amount of R-410A. [A trace amount is a maximum of 2 ounces (57 g) refrigerant or 3 pounds (31 kPa) pressure.] Close the valve on the R-410A cylinder and the valve on the high pressure side of the manifold gauge set. Disconnect R-410A cylinder.
- 4 - Connect a cylinder of nitrogen with a pressure regulating valve to the center port of the manifold gauge set.
- 5 - Adjust nitrogen pressure to 150 psig (1034 kPa). Open the valve on the high side of the manifold gauge set in order to pressurize the line set and the indoor coil.
- 6 - After a few minutes, open a refrigerant port to check that an adequate amount of refrigerant has been added for detection (refrigerant requirements will vary with line lengths). Check all joints for leaks. Purge nitrogen and R-410A mixture. Correct any leaks and re-check.

B-Evacuating the System

Evacuating the system of noncondensables is critical for proper operation of the unit. Noncondensables are defined as any gas that will not condense under temperatures and pressures present during operation of an air conditioning system. Noncondensables and water vapor combine with refrigerant to produce substances that corrode copper piping and compressor parts.

NOTE - This evacuation process is adequate for a new installation with clean and dry lines. If excessive moisture is present, the evacuation process may be required more than once.

IMPORTANT

Use a thermocouple or thermistor electronic vacuum gauge that is calibrated in microns. Use an instrument that reads from 50 microns to at least 10,000 microns.

- 1 - Connect manifold gauge set to the service valve ports :
 - low pressure gauge to vapor line service valve
 - high pressure gauge to liquid line service valve
- 2 - Connect micron gauge.
- 3 - Connect the vacuum pump (with vacuum gauge) to the center port of the manifold gauge set.
- 4 - Open both manifold valves and start the vacuum pump.
- 5 - Evacuate the line set and indoor unit to an **absolute pressure** of 23,000 microns (29.01 inches of mercury). During the early stages of evacuation, it is desirable to close the manifold gauge valve at least once to determine if there is a rapid rise in **absolute pressure**. A rapid rise in pressure indicates a relatively large leak. If this occurs, repeat the leak testing procedure.

*NOTE - The term **absolute pressure** means the total actual pressure within a given volume or system, above the absolute zero of pressure. Absolute pressure in a vacuum is equal to atmospheric pressure minus vacuum pressure.*
- 6 - When the absolute pressure reaches 23,000 microns (29.01 inches of mercury), close the manifold gauge valves, turn off the vacuum pump and disconnect the manifold gauge center port hose from vacuum pump. Attach the manifold center port hose to a nitrogen cylinder with pressure regulator set to 150 psig (1034 kPa) and purge the hose. Open the manifold gauge valves to break the vacuum in the line set and indoor unit. Close the manifold gauge valves.

⚠ CAUTION

Danger of Equipment Damage.
Avoid deep vacuum operation. Do not use compressors to evacuate a system.
Extremely low vacuums can cause internal arcing and compressor failure.
Damage caused by deep vacuum operation will void warranty.

- 7 - Shut off the nitrogen cylinder and remove the manifold gauge hose from the cylinder. Open the manifold gauge valves to release the nitrogen from the line set and indoor unit.
- 8 - Reconnect the manifold gauge to the vacuum pump, turn the pump on, and continue to evacuate the line set and indoor unit until the absolute pressure does not rise above 500 microns (29.9 inches of mercury) within a 20-minute period after shutting off the vacuum pump and closing the manifold gauge valves.
- 9 - When the absolute pressure requirement above has been met, disconnect the manifold hose from the vacuum pump and connect it to an upright cylinder of R-410A refrigerant. Open the manifold gauge valves to break the vacuum from 1 to 2 psig positive pressure in the line set and indoor unit. Close manifold gauge valves and shut off the R-410A cylinder and remove the manifold gauge set.

C-Charging

Charge Using Weigh-in Method—*Outdoor Temperature < 65°F (18°C)*

If the system is void of refrigerant, or if the outdoor ambient temperature is cool, first, locate and repair any leaks and then weigh in the refrigerant charge into the unit.

1. Recover the refrigerant from the unit.
2. Conduct leak check; evacuate as previously outlined.
3. Weigh in the unit nameplate charge. If weighing facilities are not available or if charging the unit during warm weather, use one of the following procedures.

Charge Using the Approach Method—*Outdoor Temp. ≥65°F (18°C)*

The following procedure is intended as a general guide and is for use on expansion valve systems only. For best results, outdoor temperature should be 70°F (21°C) to 80°F (26°C). Monitor system pressures while charging.

1. Record outdoor ambient temperature using a digital thermometer.
2. Attach high pressure gauge set and operate unit for several minutes to allow system pressures to stabilize.
3. Compare stabilized pressures with those provided in table 7, "Normal Operating Pressures." Minor variations in these pressures may be expected due to differences in installations. Significant differences could mean that the system is not properly charged or that a problem exists with some component in the system. Pressures higher than those listed indicate that the system is overcharged. Pressures lower than those listed indicate that the system is undercharged. Continue to check adjusted charge using approach values.
4. Use the same digital thermometer you used to check the outdoor ambient temperature to check the liquid line temperature.
5. The difference between the ambient and liquid temperatures should match values given in table 6. If the values do not agree with the those in table 6, add refrigerant to lower the approach temperature, or recover refrigerant from the system to increase the approach temperature.

TABLE 6

XC15 Approach Values						
___ ° Liquid Line Temperature — ___ ° Outdoor Temperature = ___ ° Approach Temperature						
Model	-024	-030	-036	-042	-048	-060
°F (°C)*	10 (5.6)	12 (6.7)	11 (6.1)	13 (7.2)	6 (3.3)	10 (5.6)
NOTE - For best results, use the same electronic thermometer to check both outdoor-ambient and liquid-line temperatures. *F: +/-1.0°; C: +/-0.5°						

NOTES -

R-410A refrigerant cylinders are rose-colored. Refrigerant should be added through the vapor valve in the liquid state.

Certain R-410A cylinders are identified as being equipped with a dip tube. These allow liquid refrigerant to be drawn from the bottom of the cylinder without inverting the cylinder. DO NOT turn this type cylinder upside-down to draw refrigerant.

TABLE 7

XC15 Normal Operating Pressures In psig (liquid +/- 10 and vapor +/- 5 PSIG)*												
Model	-024		-030		-036		-042		-048		-060	
	Liquid	Suction	Liquid	Suction	Liquid	Suction	Liquid	Suction	Liquid	Suction	Liquid	Suction
65 (18.3)	239	135	246	135	245	132	260	132	224	129	242	131
70 (21.1)	255	136	266	136	264	133	282	133	241	130	262	132
75 (23.9)	274	137	285	138	285	135	302	134	259	131	282	134
80 (26.7)	293	138	306	139	306	137	325	135	279	133	303	135
85 (29.4)	317	139	328	140	328	137	347	136	301	134	326	136
90 (32.2)	339	140	350	141	352	139	370	137	323	135	349	137
95 (35.0)	362	141	374	142	375	140	395	138	347	137	372	138
100 (37.8)	387	142	399	143	400	141	421	139	372	138	397	140
105 (40.6)	415	144	423	144	425	141	446	141	397	140	422	141
110 (43.3)	440	145	450	145	452	143	475	142	422	141	448	143
115 (46.1)	469	146	477	146	476	144	504	144	449	143	475	146

* These are typical pressures only. Indoor match up, indoor air quality, and indoor load will cause the pressures to vary.
 ** Temperature of air entering outdoor coil.

Charge Using Subcooling Method—Outdoor Temperature $\geq 65^{\circ}\text{F}$ (18°C)

Use the following method to obtain accurate subcooling values. Compare the measured subcooling value to the values given in table 8.

Table 8

XC15 Subcooling Values						
(psig _____)	_____° Saturation Temperature					
— _____	_____° Liquid Line Temperature					
= _____	_____° Subcooling Value					
Model	-024	-030	-036	-042	-048	-060
°F (°C)*	4 (2.2)	4 (2.2)	6 (3.3)	7 (3.9)	6 (3.3)	7 (3.9)

NOTE - For best results, use the same electronic thermometer to check both outdoor-ambient and liquid-line temperatures.
 *F: +/-1.0°; C: +/-0.5°

1. With the manifold gauge hose still on the liquid service port and the unit operating stably, use a digital thermometer to record the **liquid line temperature** in the space provided in table 8, and at the same time, record the **liquid line pressure** reading in the "(psig_____)" space in the table.
2. Use a temperature/pressure chart for R-410A (table 9) to determine the **saturation temperature** for the liquid line pressure reading and record that in the space provided in table 8.

3. Subtract the liquid line temperature from the saturation temperature (according to the chart) to determine the **subcooling value**.
4. Compare subcooling value with those in table 8. If subcooling is greater than shown, recover some refrigerant; if less than shown, add some refrigerant.

Charge using Subcooling Method—Outdoor Temperature $< 65^{\circ}\text{F}$ (18°C)

When the outdoor ambient temperature is below 65°F (18°C), use the subcooling method to charge the unit. It may be necessary to restrict the air flow through the outdoor coil to achieve pressures in the 325-375 psig (2240-2585 kPa) range. These higher pressures are necessary for checking the charge. Block equal sections of air intake panels and move obstructions sideways until the liquid pressure is in the 325-375 psig (2240-2585 kPa) range. See figure 13.

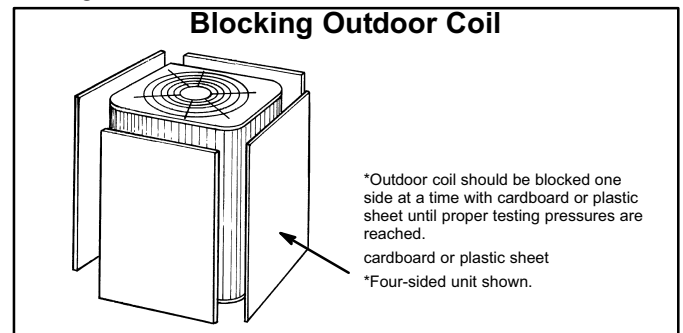

FIGURE 13

TABLE 9
R-410A Temperature/Pressure Chart

R-410A Temperature (°F) - Pressure (Psig)							
°F	Psig	°F	Psig	°F	Psig	°F	Psig
32	100.8	63	178.5	94	290.8	125	445.9
33	102.9	64	181.6	95	295.1	126	451.8
34	105.0	65	184.3	96	299.4	127	457.6
35	107.1	66	187.7	97	303.8	128	463.5
36	109.2	67	190.9	98	308.2	129	469.5
37	111.4	68	194.1	99	312.7	130	475.6
38	113.6	69	197.3	100	317.2	131	481.6
39	115.8	70	200.6	101	321.8	132	487.8
40	118.0	71	203.9	102	326.4	133	494.0
41	120.3	72	207.2	103	331.0	134	500.2
42	122.6	73	210.6	104	335.7	135	506.5
43	125.0	74	214.0	105	340.5	136	512.9
44	127.3	75	217.4	106	345.3	137	519.3
45	129.7	76	220.9	107	350.1	138	525.8
46	132.2	77	224.4	108	355.0	139	532.4
47	134.6	78	228.0	109	360.0	140	539.0
48	137.1	79	231.6	110	365.0	141	545.6
49	139.6	80	235.3	111	370.0	142	552.3
50	142.2	81	239.0	112	375.1	143	559.1
51	144.8	82	242.7	113	380.2	144	565.9
52	147.4	83	246.5	114	385.4	145	572.8
53	150.1	84	250.3	115	390.7	146	579.8
54	152.8	85	254.1	116	396.0	147	586.8
55	155.5	86	258.0	117	401.3	148	593.8
56	158.2	87	262.0	118	406.7	149	601.0
57	161.0	88	266.0	119	412.2	150	608.1
58	163.9	89	270.0	120	417.7	151	615.4
59	166.7	90	274.1	121	423.2	152	622.7
60	169.6	91	278.2	122	428.8	153	630.1
61	172.6	92	282.3	123	434.5	154	637.5
62	175.4	93	286.5	124	440.2	155	645.0

V-SERVICE AND RECOVERY

⚠ WARNING

Polyol ester (POE) oils used with R-410A refrigerant absorb moisture very quickly. It is very important that the refrigerant system be kept closed as much as possible. DO NOT remove line set caps or service valve stub caps until you are ready to make connections.

⚠ IMPORTANT

USE RECOVERY MACHINE RATED FOR R-410A REFRIGERANT.

If the XC15 system must be opened for any kind of service, such as compressor or filter drier replacement, you must take extra precautions to prevent moisture from entering the system. The following steps will help to minimize the amount of moisture that enters the system during recovery of R-410A.

- 1 - Use a regulator-equipped nitrogen cylinder to break the system vacuum. Do not exceed 5 psi. The dry nitrogen will fill the system, purging any moisture.
- 2 - Remove the faulty component and quickly seal the system (using tape or some other means) to prevent additional moisture from entering the system.
- 3 - Do not remove the tape until you are ready to install new component. Quickly install the replacement component.
- 4 - Evacuate the system to remove any moisture and other non-condensables.

The XC15 system MUST be checked for moisture anytime the system is opened.

Any moisture not absorbed by the polyol ester oil can be removed by triple evacuation. Moisture that has been absorbed by the compressor oil can be removed by replacing the filter drier.

⚠ IMPORTANT

Evacuation of system only will not remove moisture from oil. Filter drier must be replaced to eliminate moisture from POE oil.

VI-SR1 SOUND REDUCTION

Figure 14 identifies the sound reduction components and shows the correct procedure for assembling the sound reduction cover.

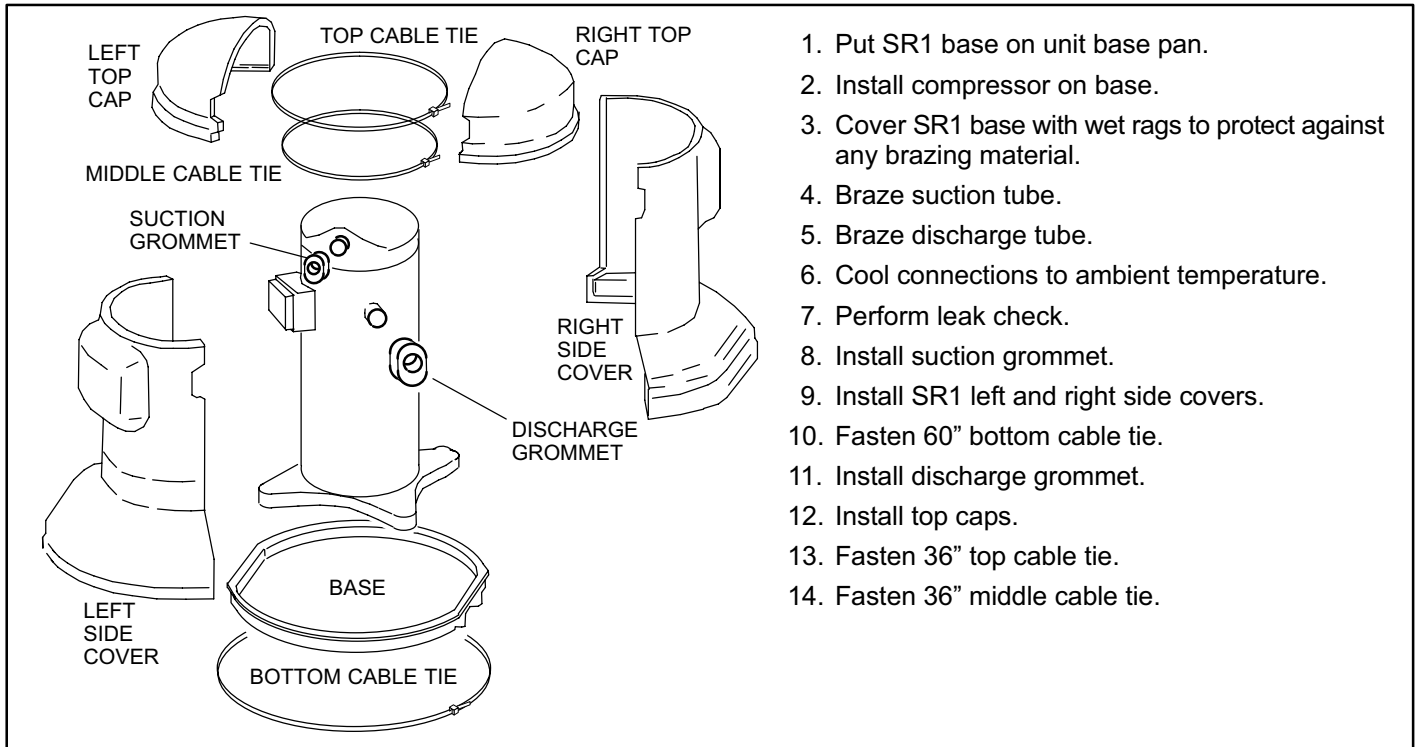



FIGURE 14

VII-MAINTENANCE

⚠ WARNING	
	Electric shock hazard. Can cause injury or death. Before attempting to perform any service or maintenance, turn the electrical power to unit OFF at disconnect switch(es). Unit may have multiple power supplies.

See section II- for removing access panels. Maintenance and service must be performed by a qualified installer or service agency. At the beginning of each cooling season, the system should be checked as follows:

- 1 - Clean and inspect the outdoor coil. The coil may be flushed with a water hose. Ensure the power is turned off before you clean the coil.
- 2 - Condenser fan motor is prelubricated and sealed. No further lubrication is needed.
- 3 - Visually inspect connecting lines and coils for evidence of oil leaks.
- 4 - Check wiring for loose connections.
- 5 - Check for correct voltage at unit (unit operating).
- 6 - Check amp-draw on condenser fan motor.

NOTE - If owner complains of insufficient cooling, the unit should be gauged and refrigerant charge checked. Refer to section on refrigerant charging in this instruction.

VIII-DIAGRAMS / OPERATING SEQUENCE

A- Unit Diagram XC15-024/060-1P

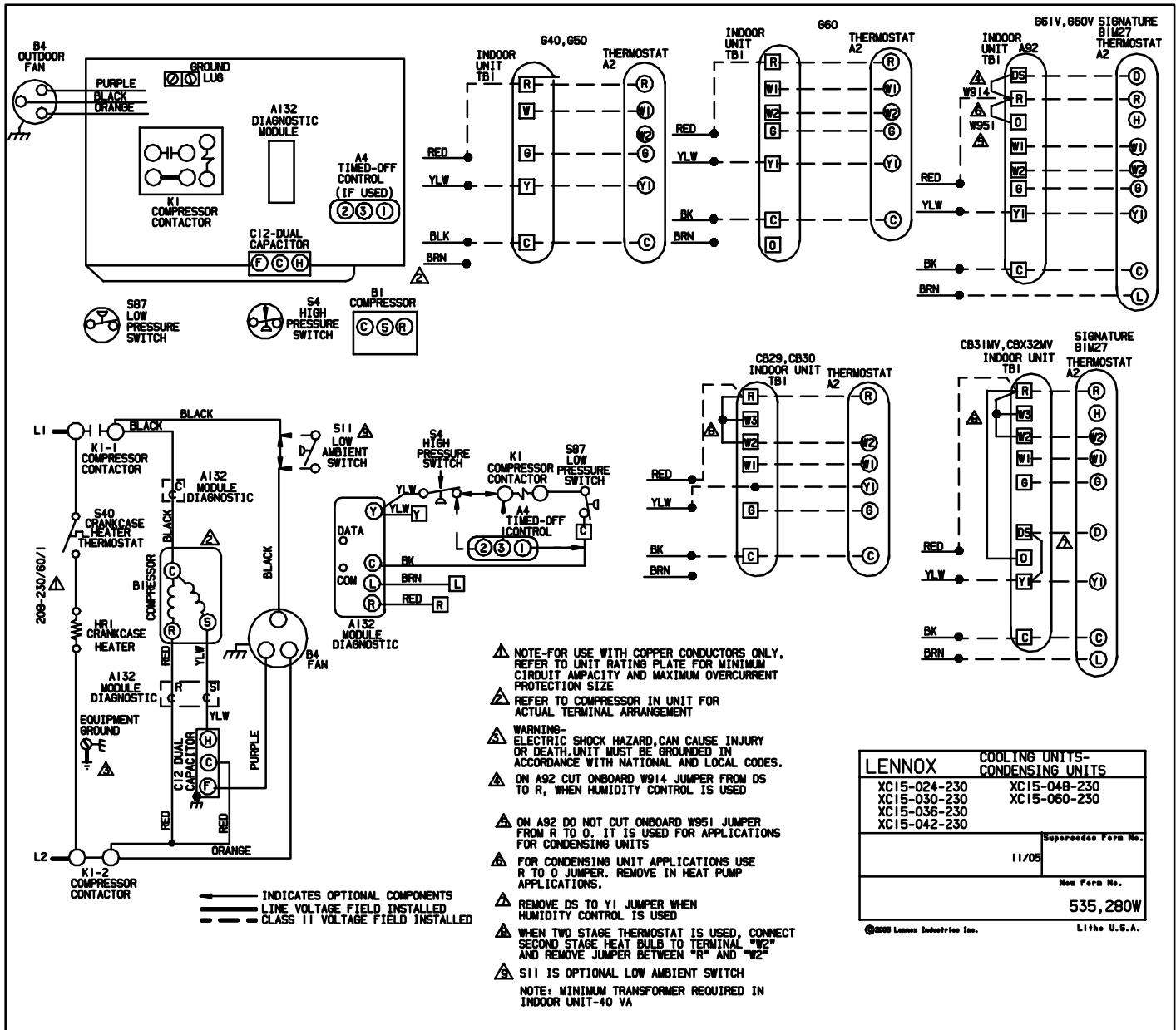

Sequence of Operation

Cooling Demand

- Cooling demand initiates at Y1 in the thermostat.
- Voltage from terminal Y passes through the TOC (if used) through S4 high pressure switch, energizes K1 compressor contactor, passes through S87 low pressure switch and returns to common side of the 24VAC power.
- K1 closes energizing compressor B1 and outdoor fan B4. Outdoor fan motor is energized.

End of Cooling Demand

- Cooling demand is satisfied. Terminal Y1 is de-energized.
- Contactor K1 is de-energized.
- K1-1 opens, compressor B1 and outdoor fan B4 are de-energized.